



Evolution of the 3GPP Network Architecture, (the Evolved Packet Core)

Dr. Sungho Choi
Vice Chairman of 3GPP TSG SA

Air Interface Technology Evolution



OFDMA

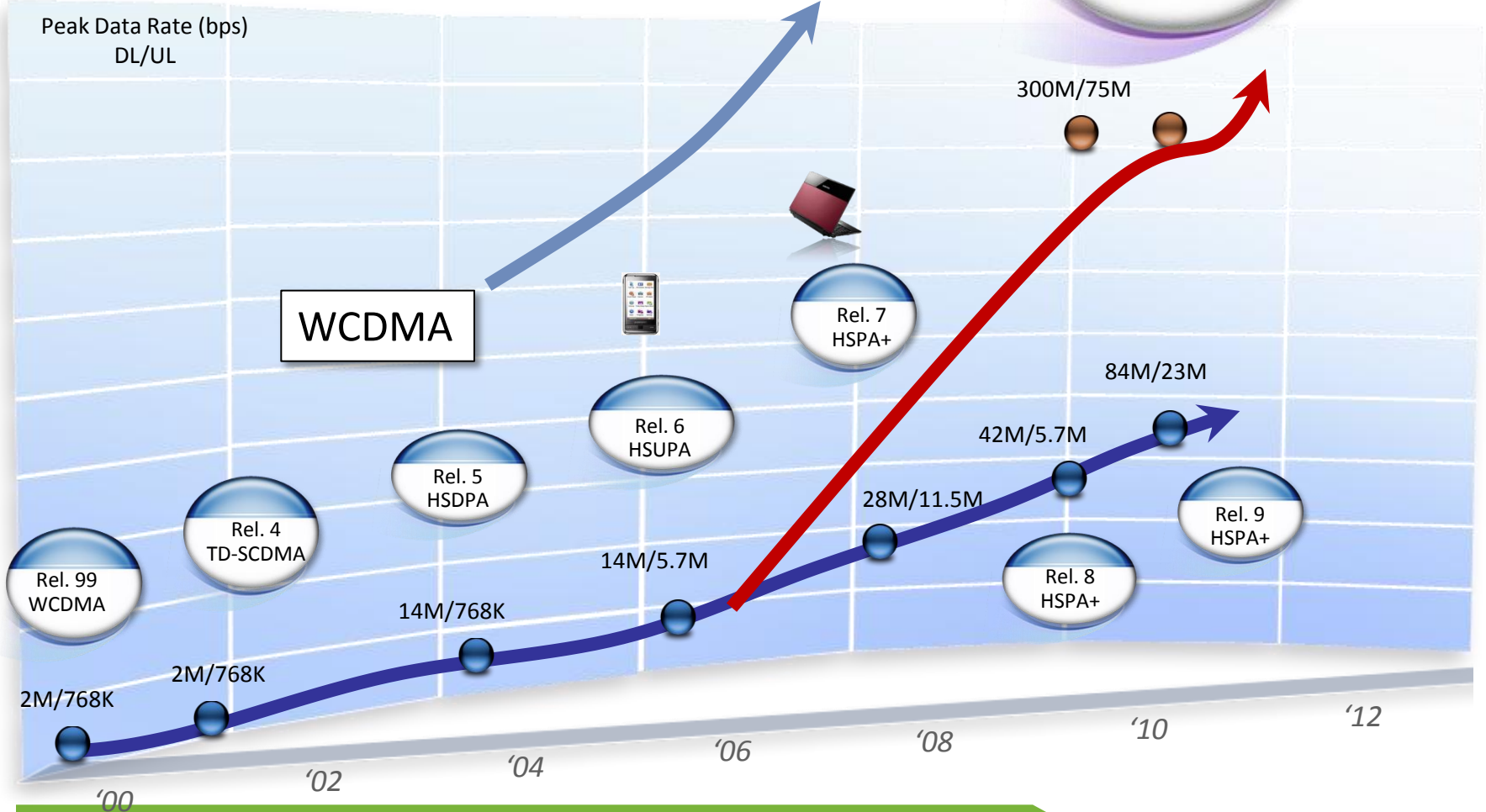



Network Architecture Evolution

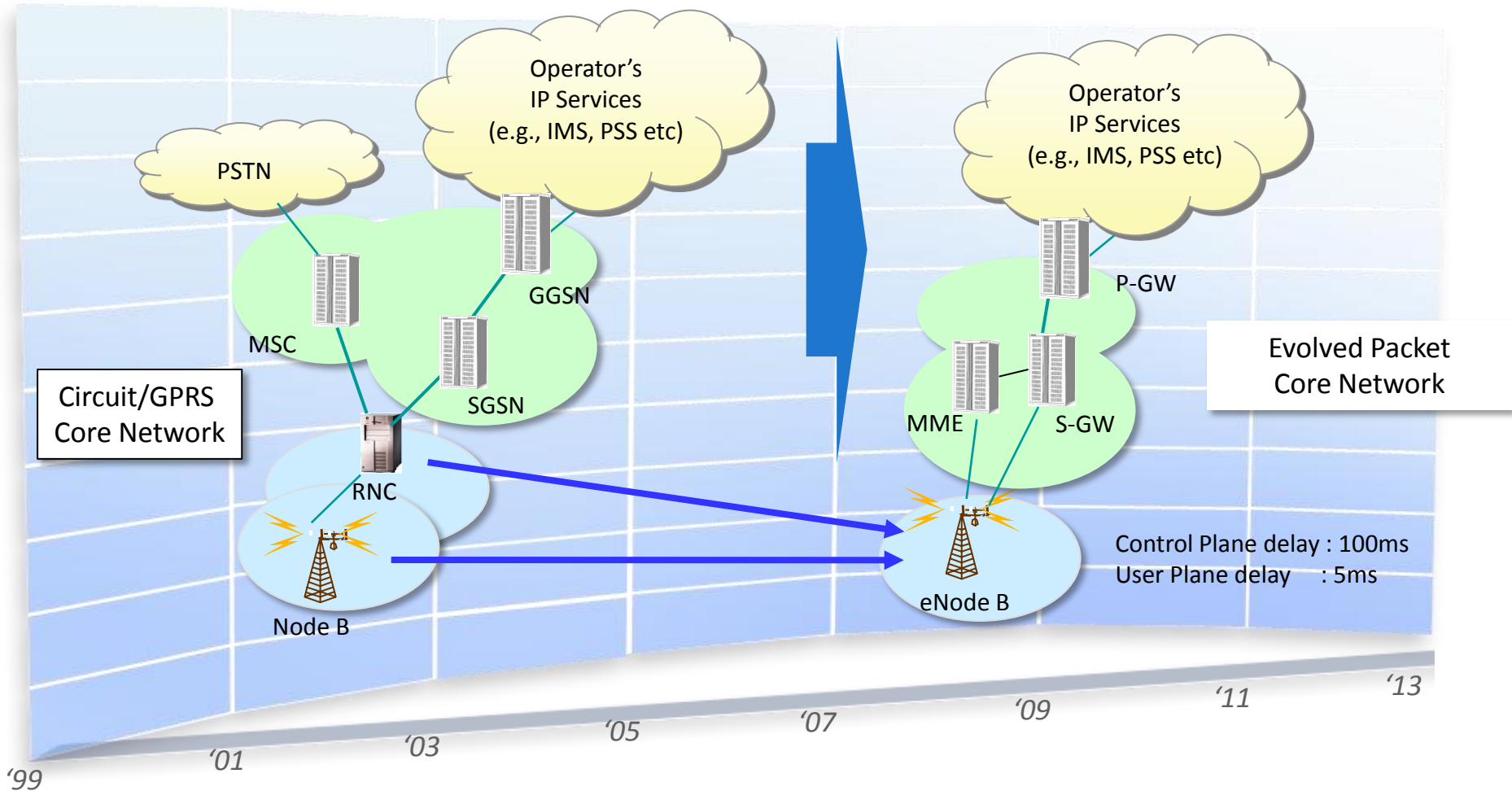



3GPP Organization structure

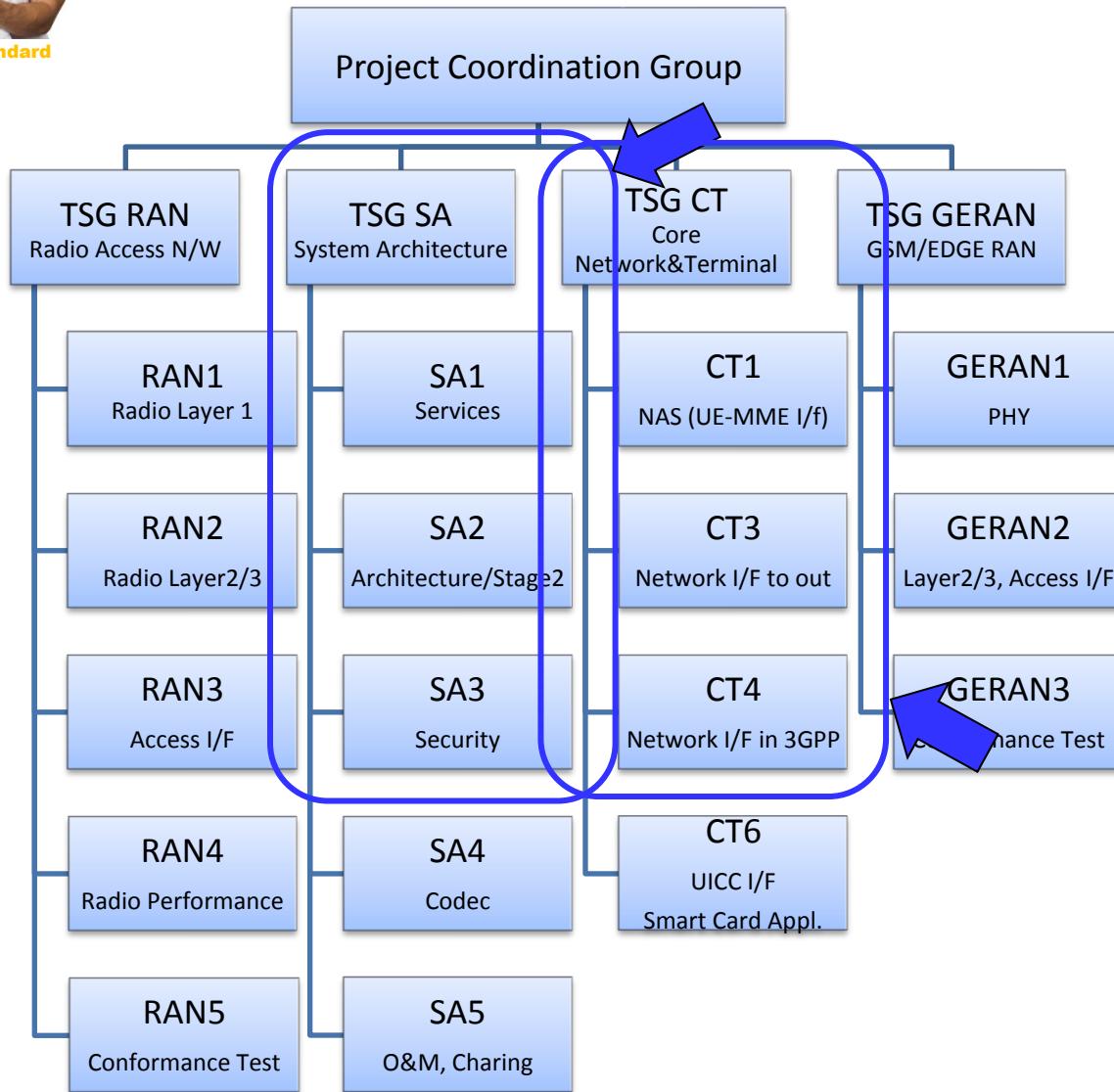



Key LTE/SAE Features



Rel.8 LTE (~09/03)

- 20MHz, OFDM New Air
- DL 4x4 MIMO
- SON, HeNB

- **SAE For LTE Access**
- **CS Fallback in EPS**
- **Single Radio VCC**

- Peak: DL 300Mbps,
UL 75Mbps



Rel.9 LTE (~10/03)

- Enhanced Dual-Layer Tx
- SON/HeNB Enhancement

- IMS Emergency Calls
- LCS for LTE and EPS
- MBMS support in EPS

- Peak: DL 300Mbps,
UL 75Mbps

SON: Self Organizing Network, HeNB: Home eNB, SAE: System Architecture Evolution

Evolved Packet System architecture



THE Mobile Broadband Standard

- Many 3GPP access technologies
- Mobility between access technologies
- Multiple roaming models
- Non-3GPP accesses

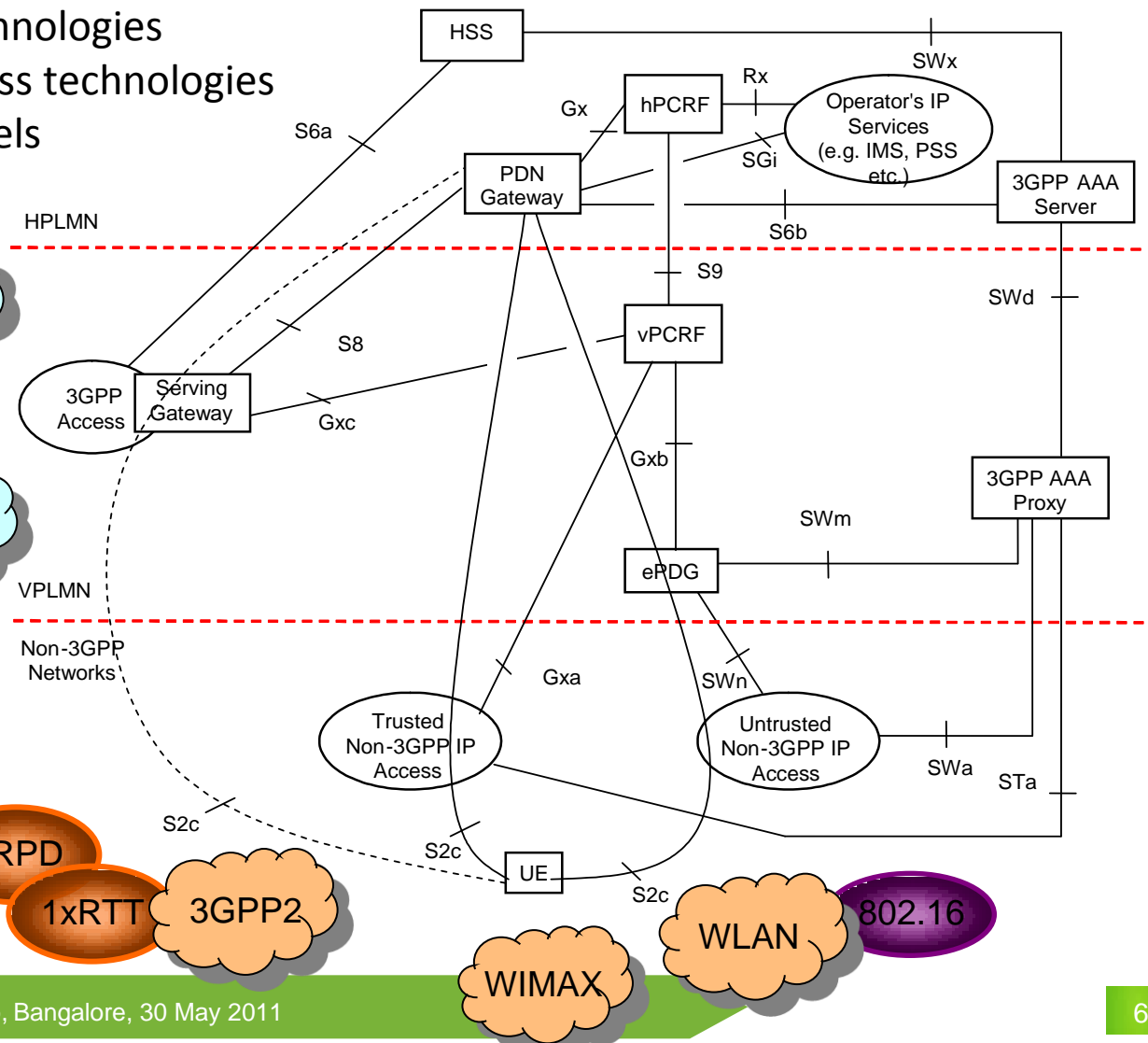
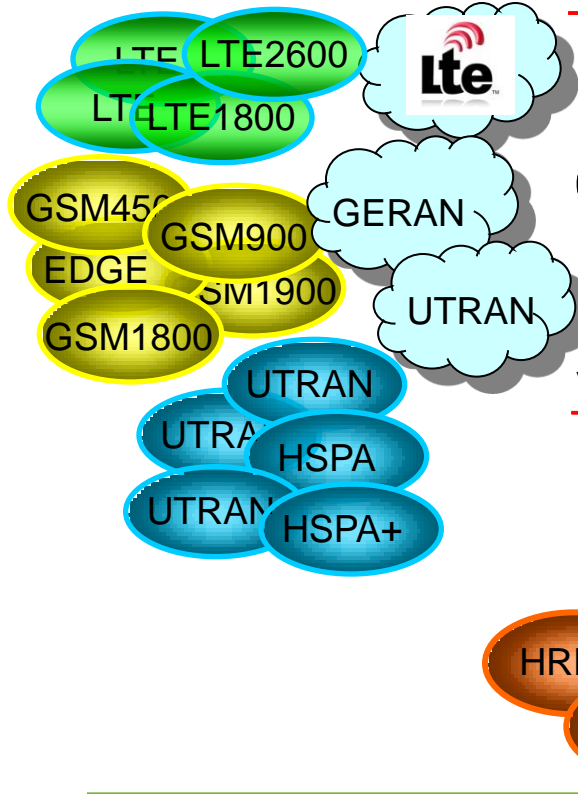



CS Fallback in EPS

Application of CSFB:

- CS capable device camping on LTE cell can establish/receive **CS services**
- Reuse of **existing CS** infrastructure for voice service until IMS VoIP is deployed
- Provide voice **roaming** support with LTE
- Can support **emergency calls** using existing CS infrastructure

 **SMS** can be delivered to the UE without redirecting to CS Domain

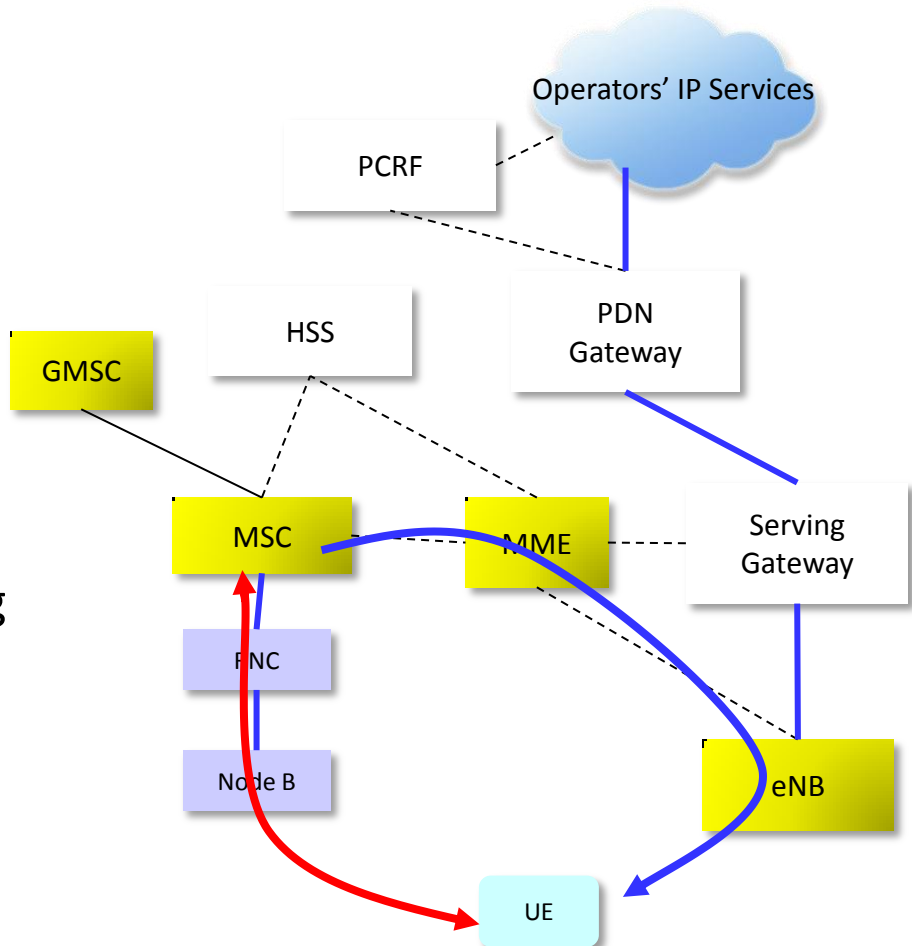



Single Radio Voice Call Continuity

SRVCC use case:

- IMS call initiated in LTE can continue in CS domain after **moving outside of** LTE coverage area
- SR-VCC is invoked if **no other VoIP** capable PS system (HSPA/eHRPD) is available for VoIP PS-PS HO
- Requires overlapping with **GSM/WCDMA/1xRTT coverage**

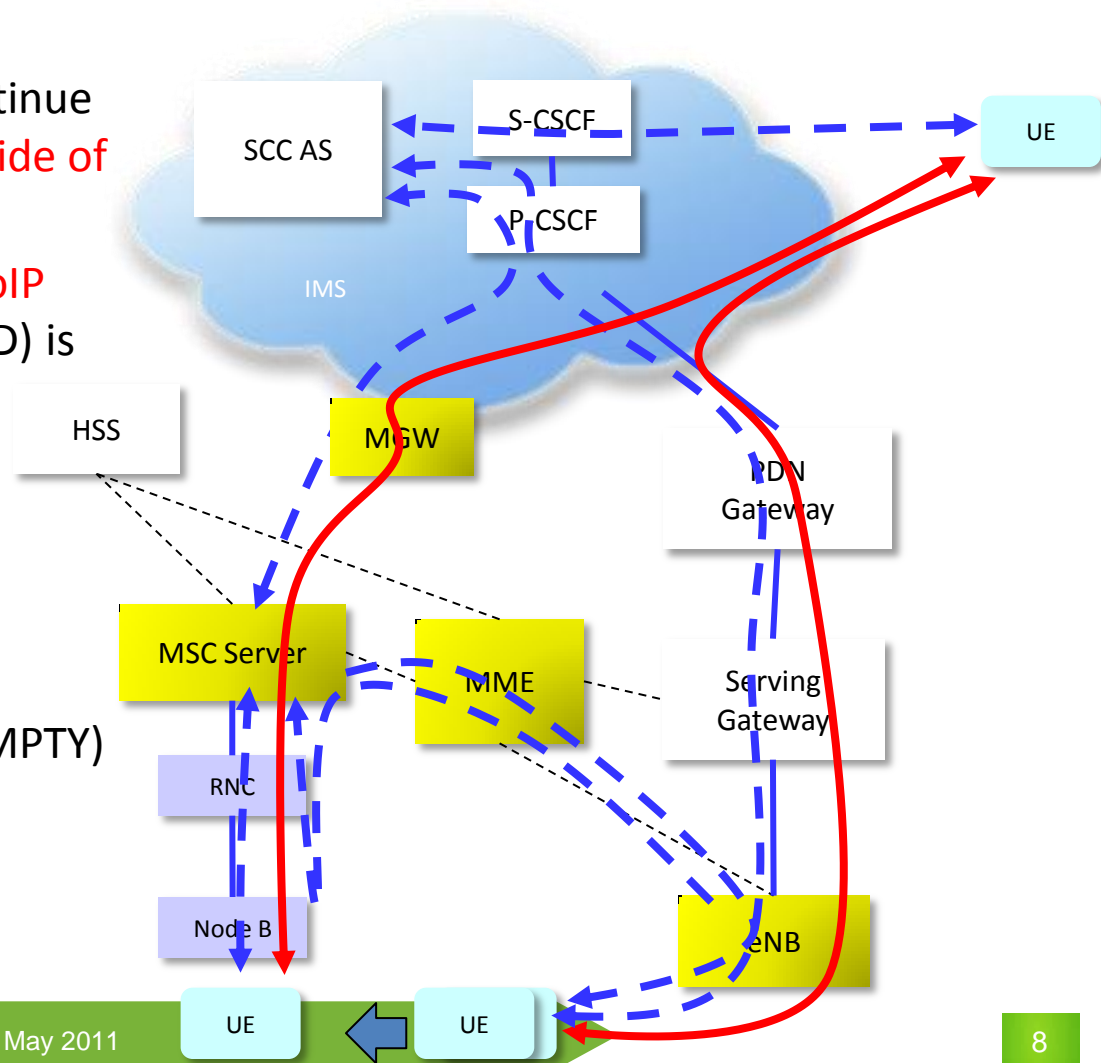

SRVCC improvements:

- Mid-call services (like HOLD & MPTY)
- emergency calls
- video calls



3GPP Schedule

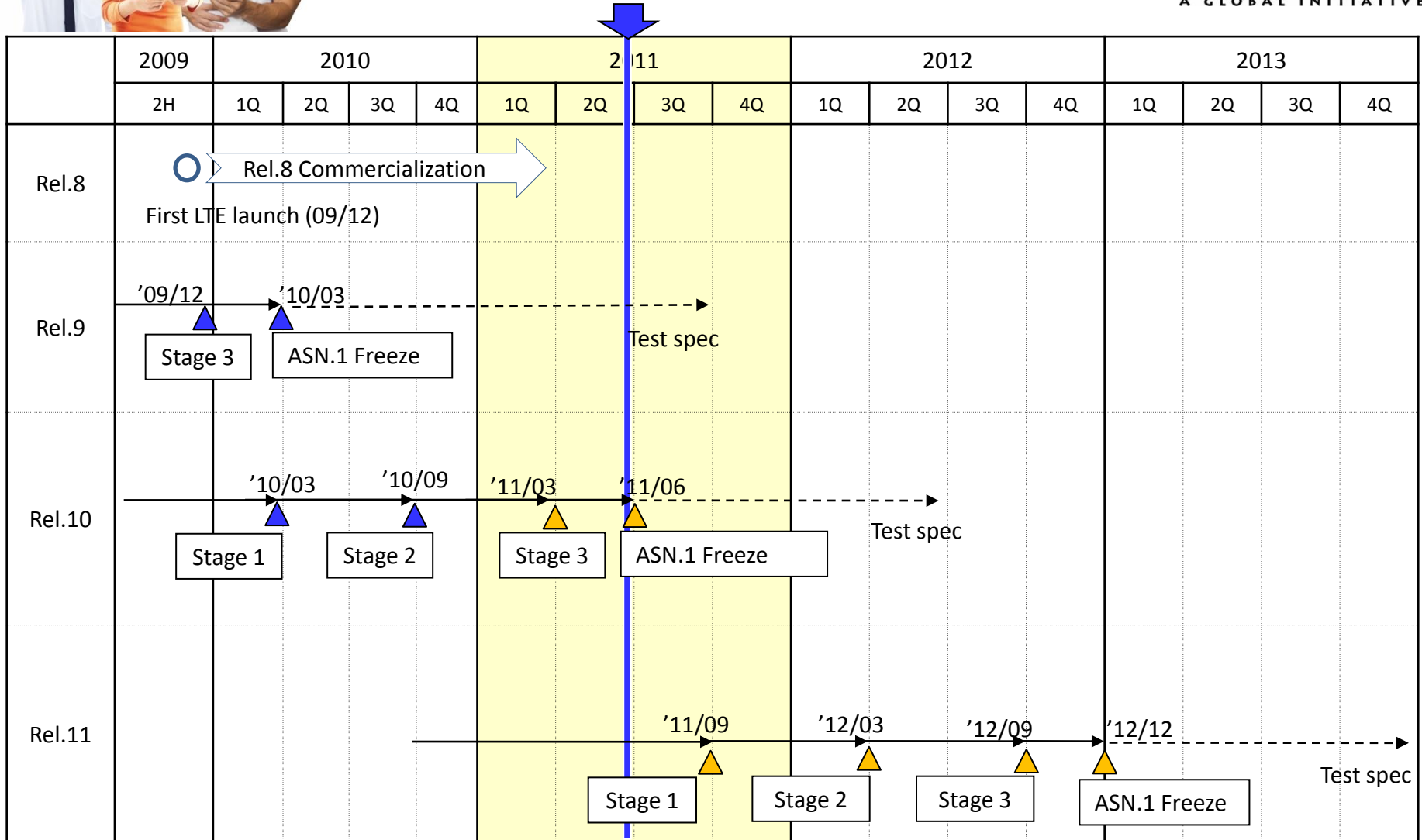



THE Mobile Broadband Standard

Key Rel.10/Rel.11 Features

Rel.8 LTE (~09/03)

- 20MHz, OFDM New Air
- DL 4x4 MIMO/ UL 1x2 MIMO
- SON, HeNB
- SAE For LTE Access
- CS Fallback in EPS
- Single Radio VCC
- Peak: DL 300Mbps, UL 75Mbps

Rel.9 LTE (~10/03)

- Enhanced Dual-Layer Tx
- SON/HeNB Enhancement
- IMS Emergency Calls
- LCS for LTE and EPS
- MBMS support in EPS
- Peak: DL 300Mbps, UL 75Mbps

Rel.10 LTE-Adv (~11/06)

- DL 8x8 MIMO, UL 4x4 MIMO
- Carrier Aggregation
- HetNet, MDT
- **HeNB Local IP Access**
- **Wifi offloading**
- **Machine Type Communication**
- Peak: DL 1Gbps, UL 500 Mbps

Rel.11 (~12/12)

- CoMP
- Enhancement of Rel.10 features
- System Improvement of MTC
- Service Awareness and Privacy Policies
- IW MNO and Application Provider
- Data Application Impacts

Local IP Access (LIPA)



THE Mobile Broadband Standard

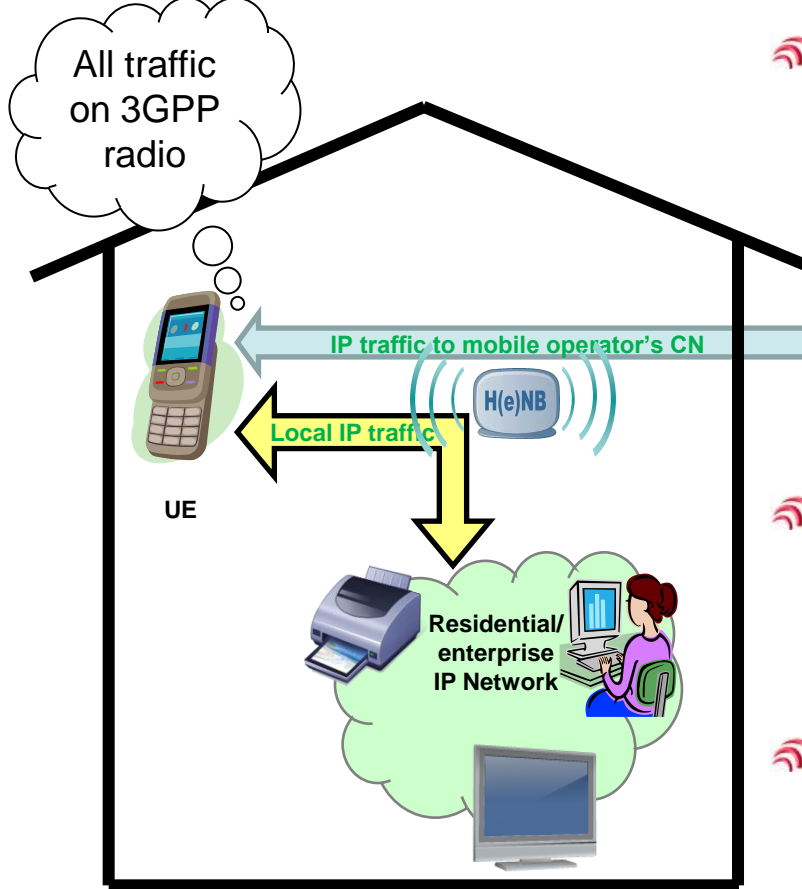

LIPA is primarily for end user's benefit, to allow access to **local residential or corporate network** through a 3GPP device

LIPA provides access for IP capable UEs that are connected via a **H(e)NB subsystem** to other IP capable entities in the same residential/enterprise IP network.

Simultaneous access from a UE to the mobile operator's core network and Local IP Access to a residential/enterprise IP network will be supported.



WLAN Offloading



- WLAN offloading refers to the **dual radio scenario** where part of the traffic is routed via WLAN access and part via 3GPP access
- WLAN offloading covers both the scenario where the traffic via WLAN radio is **anchored in the EPC** (i.e., seamless offloading) and the scenario where it is not anchored (i.e., non-seamless offloading)
- Access Network Discovery and Selection Function (ANDSF)** is there to provide the UE with the access network discovery information and the policy on how to use the available access networks

- Available access networks
- Preferred routing of the traffic per APN, per IP flow

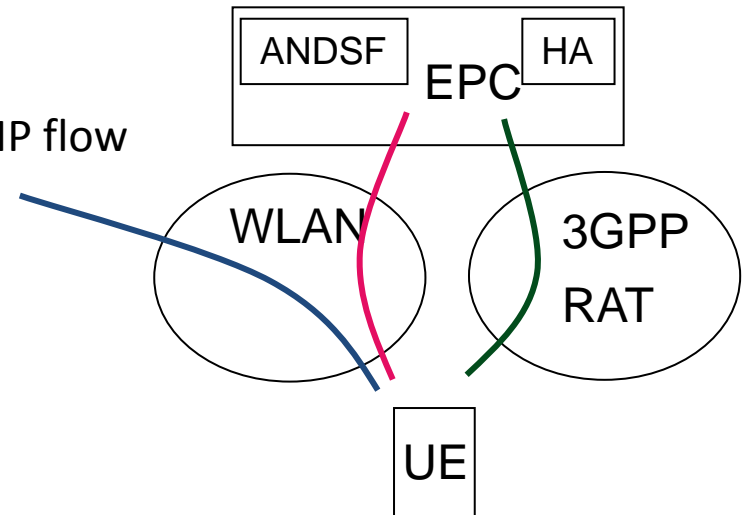



Machine Type Communication



- M2M is recognized as a key segment in future packet networks
- Initial 3GPP efforts have focused on the ability to differentiate machine-type devices
 - This allows the operator to selectively handle such devices in overload situations
 - Low priority indicator has been added to the relevant UE-network procedures
 - Overload and Congestion control is done on both core network and radio access network based on this indicator

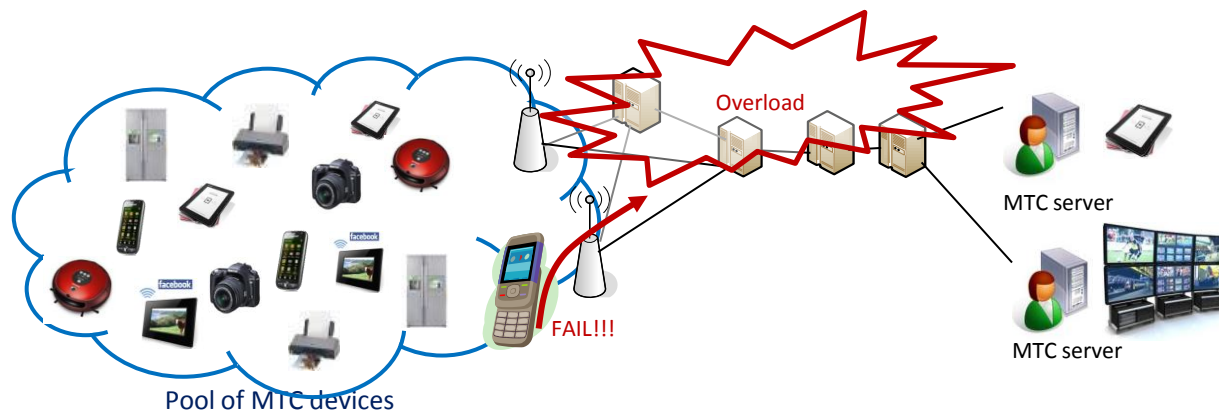



MTC – basic architecture



 Work in progress...

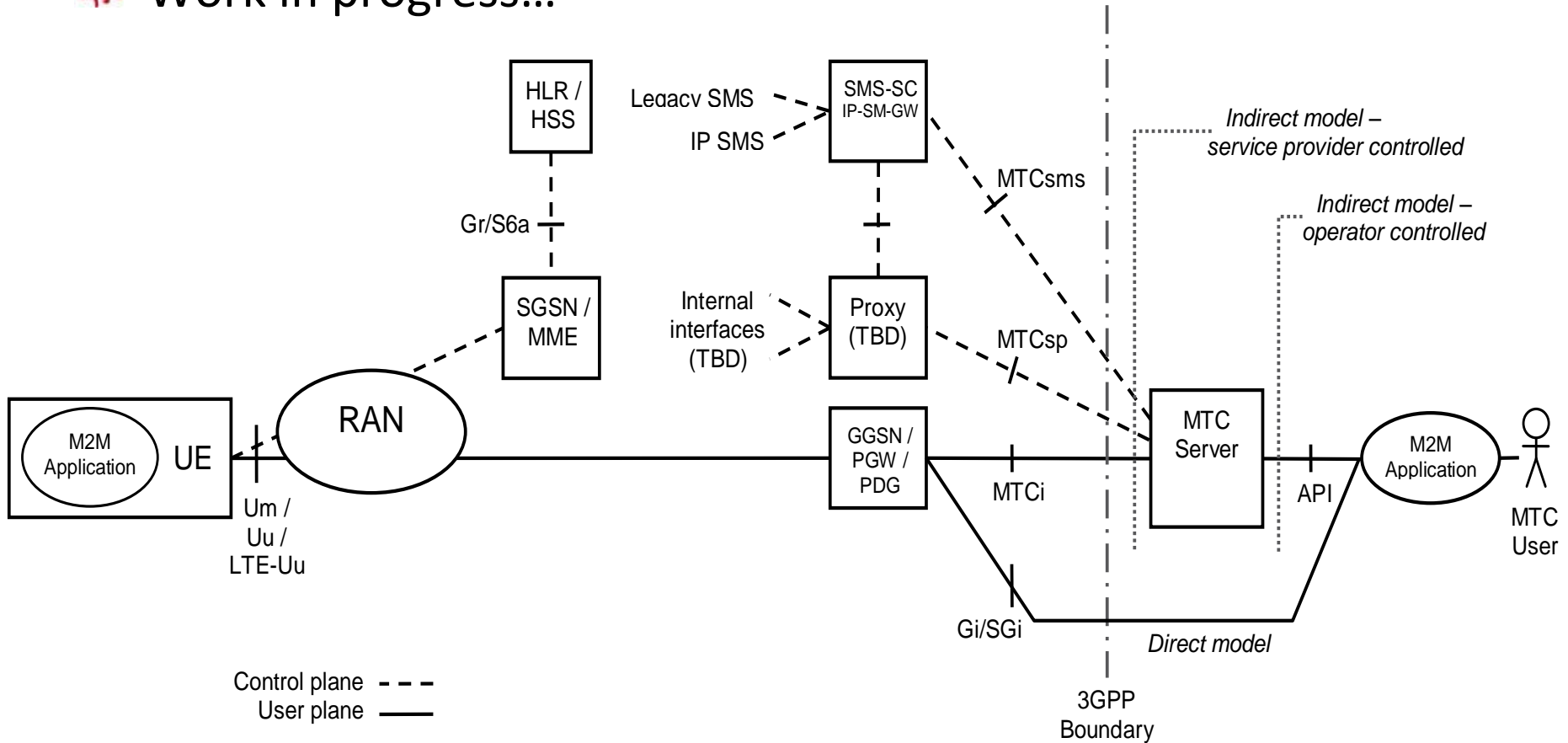



Evolution of MTC



 Further functionality being added to 3GPP standards in the following areas

- Reachability Aspects, MTC Feature control, Device Triggering
- Addressing, Identifiers - especially removal of MSISDN dependencies in the architecture
- Signaling Optimizations, Small Data Transmissions, MTC Monitoring

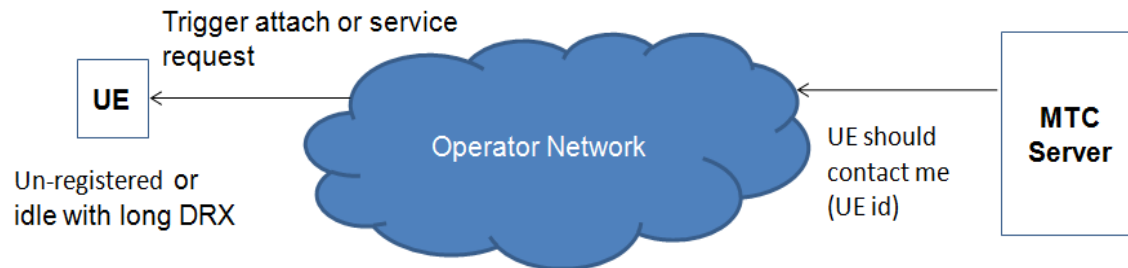

 MTC is a substantial technical area, full completion will span across multiple future Releases



Rel.11: Service Awareness and Privacy Policies

Analyzing traffic, standardization of detecting the service traffic and applying the policy

- Traffic Detection Function newly defined
- Performs the following for the Detected traffic
 - Gating of the detected service traffic either blocking or permitting unrestricted
 - Traffic Shaping of the detected service traffic
 - Redirecting of detected service traffic

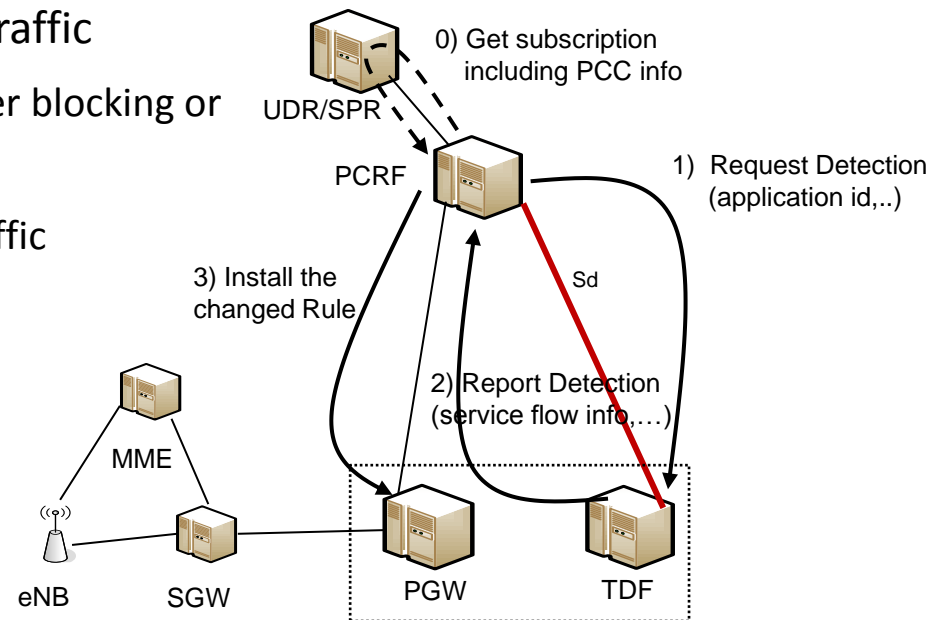

TDF: Traffic Detection Function



Rel.11: IW MNO and Data Application Provider

Interface will be provided toward 3rd Party Data Application Provider

- The following services will be proved over the newly defined interface
 - Customised billing/charging, Promotion services, Group addressing capabilities, identity services, statistics etc

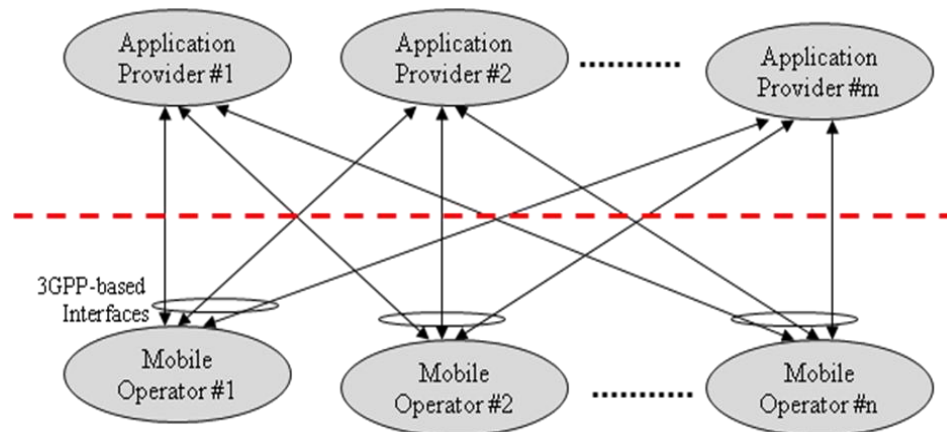



Study on Non-MTC Mobile Data Application Impacts

Study on Service Scenario and Use case on Mobile data application

Study on Network inefficiency from Mobile data application

(Problem 1)

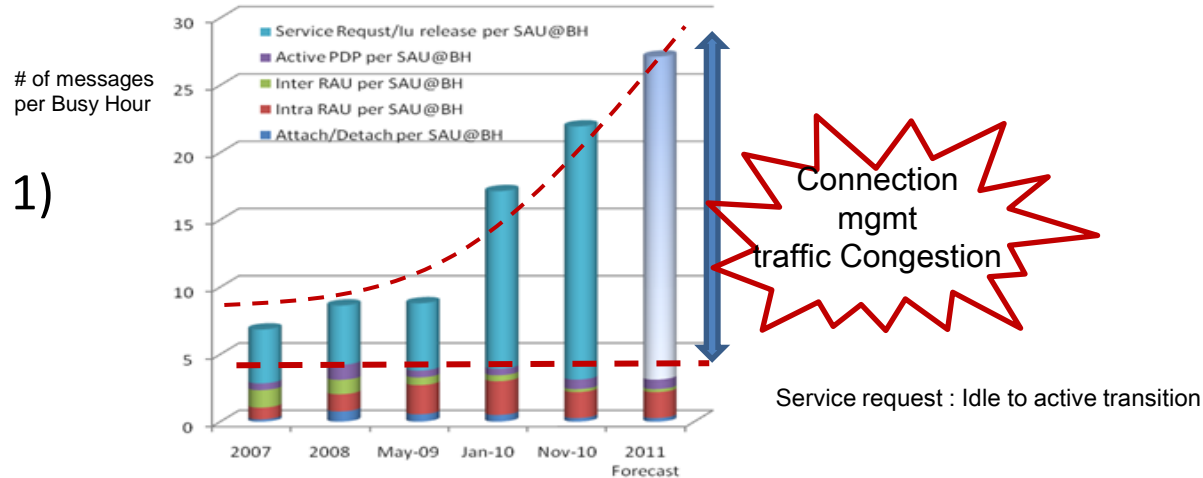

(Problem 2)

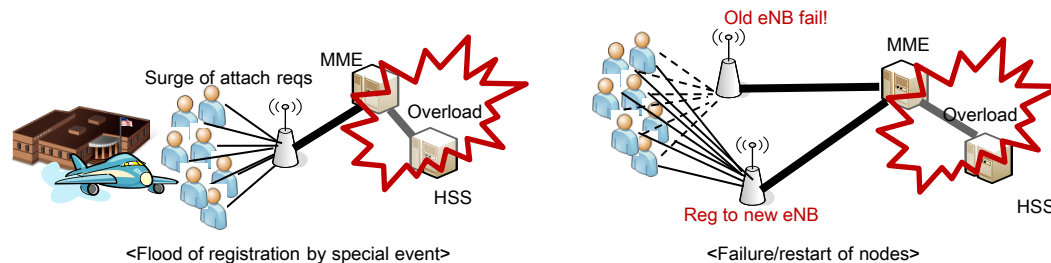

Thank You



THE Mobile Broadband Standard

Dr. Sungho Choi
3GPP TSG SA chairman
+82 31 279 5116
schoi@samsung.com

More Information about 3GPP:



www.3gpp.org

contact@3gpp.org